

METHODIST GIRLS' SCHOOL

Founded in 1887



END-OF-YEAR EXAMINATION 2021 PRIMARY 5 SCIENCE

BOOKLET A

Total Time for Booklets A and B: 1 hour 45 minutes

INSTRUCTIONS TO CANDIDATES

Do not turn over this page until you are told to do so.

Follow all instructions carefully.

Answer all questions.

Shade your answers in the Optical Answer Sheet (OAS) provided.

Name: _____ ()

Class: Primary 5. _____

Date : 26 October 2021

This booklet consists of 18 printed pages including this page.

For each question from 1 to 28, four options are given. One of them is the correct answer. Make your choice (1, 2, 3 or 4). Shade the correct oval on the Optical Answer Sheet (OAS).

[56 marks]

- 1 Some animals are classified into three groups as shown below.

A	B	C
cat	duck	lizard
sheep	eagle	crocodile

They are grouped according to _____.

- (1) where they live
 (2) their movement
 (3) their outer body covering
 (4) their method of reproduction
- 2 Which of the following statements about the life cycles of a chicken and a grasshopper are correct?
- A Both life cycles have a nymph stage.
 B The young in both life cycles look like the adult.
 C Both animals go through their life cycles on land.
 D The young in both life cycles go through moulting.
- (1) A and B only
 (2) A and D only
 (3) B and C only
 (4) B, C and D only

- 3 Divya observed some mosquitoes, butterflies and frogs living in her garden. The number of days needed for their eggs to hatch is shown below.

Characteristic	Mosquito	Butterfly	Frog
Number of days needed for eggs to hatch	2	3	5

On day 10, what would Divya most likely find in the pond of her garden?

- (1) frog eggs and caterpillars
 (2) mosquito larvae and tadpoles
 (3) frog eggs and mosquito larvae
 (4) mosquito larvae and caterpillars

(Go on to the next page)

- 4 Moss is a tiny non-flowering plant. It grows well at the bottom of tree trunks in forests.

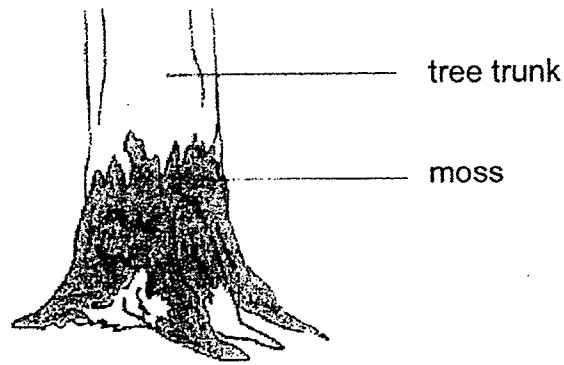

Suresh wants to grow moss in his garden. How can he help the moss grow well?

- (1) Water the moss daily.
- (2) Attract bees to his garden.
- (3) Grow the moss under bright sunlight.
- (4) Attract insects to help disperse fruits.

- 5 Old car tyres can be tied together and used to form a wall along racing tracks. This helps to protect racers and spectators when accidents happen.

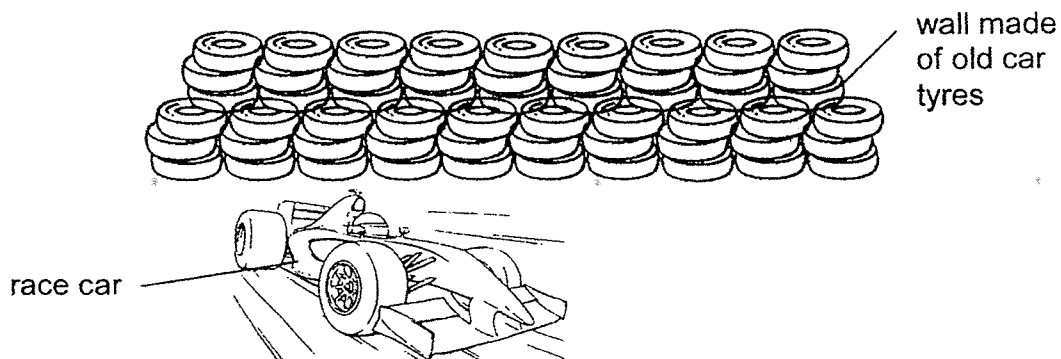

Which properties of the material used to make the old car tyres help to ensure safety?

- (1) Strong and flexible.
- (2) Waterproof and weak.
- (3) Strong and able to float in water.
- (4) Waterproof and allows light to pass through.

(Go on to the next page)

6 Study the flowchart below.

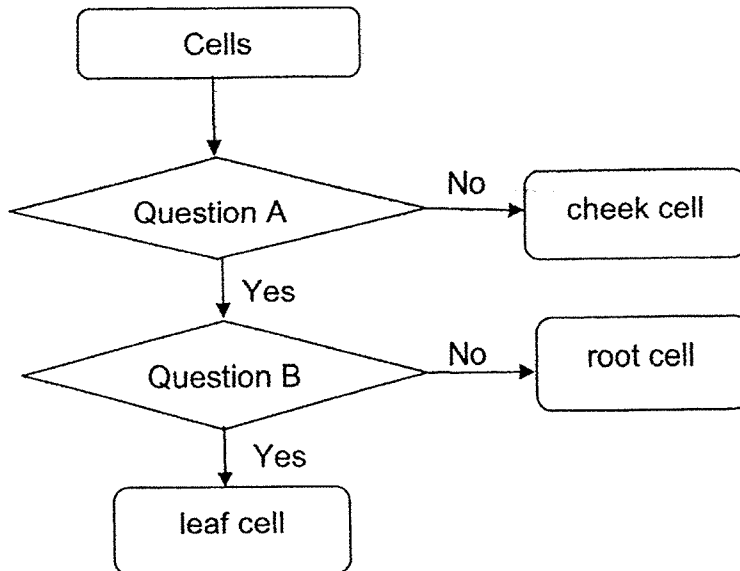

What are questions A and B?

	A	B
(1)	Does the cell have chloroplasts?	Does the cell have a cell wall?
(2)	Does the cell have a cell wall?	Does the cell have chloroplasts?
(3)	Does the cell have a nucleus?	Does the cell have a cell membrane?
(4)	Does the cell have a cell membrane?	Does the cell have a nucleus?

(Go on to the next page)

- 7 Study the cell as shown below.

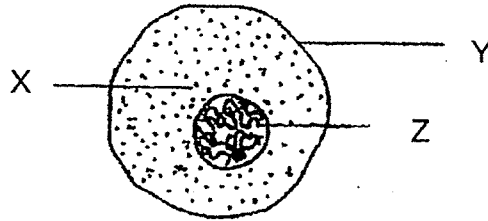

Which of the following statement(s) is/are true?

- A X is a jelly-like substance.
- B Y gives the cell its fixed shape.
- C Z contains genetic information of the cell.

- (1) A and B only
- (2) A and C only
- (3) B and C only
- (4) A, B and C

- 8 The diagram below shows a human reproductive system with parts labelled.

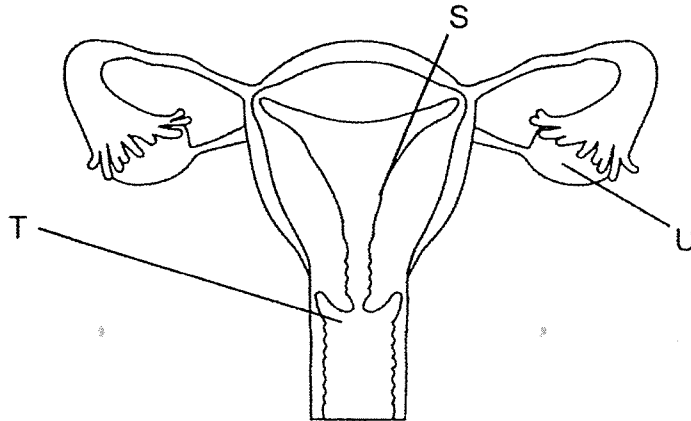

Which of the following statement(s) are true?

- A Ovules can be found in U.
- B T contains female reproductive cells.
- C S is where the fertilised egg attaches itself to grow.

- (1) A only
- (2) C only
- (3) A and B only
- (4) B and C only

(Go on to the next page)

- 9 The picture below shows two parts, X and Y, taken from a plant.

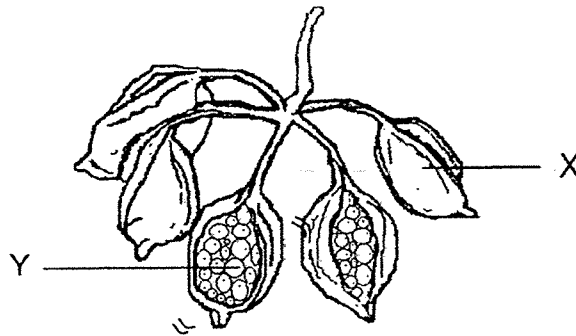

Which of the statement(s) is/are correct?

- A X helps to disperse Y.
- B Y is developed from an ovary.
- C X and Y are formed from flowers.

- (1) A only
- (2) B only
- (3) A and C only
- (4) B and C only

- 10 The diagram shows the life cycle of a flowering plant.

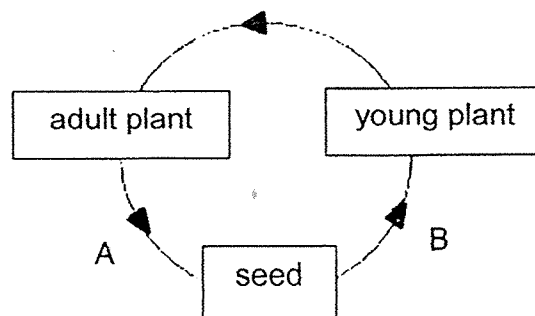

Which of the following correctly represent the processes, A and B?

	Process(es) at A	Process(es) at B
(1)	fertilisation	pollination
(2)	dispersal	pollination and fertilisation
(3)	pollination and fertilisation	dispersal and germination
(4)	pollination and germination	fertilisation and dispersal

(Go on to the next page)

11. The diagram below shows how food and water are transported to different parts of a plant.

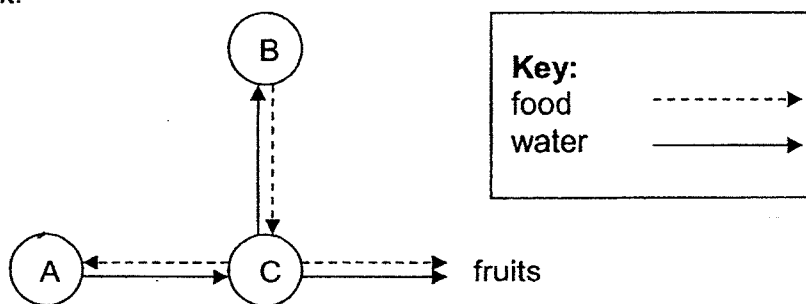

Which of the following best represent the parts of the plant, A, B and C?

	A	B	C
(1)	stem	leaves	roots
(2)	roots	leaves	stem
(3)	leaves	flowers	roots
(4)	flowers	stem	leaves

12. The diagram below shows the seed dispersal patterns of plants C, D, E and F.

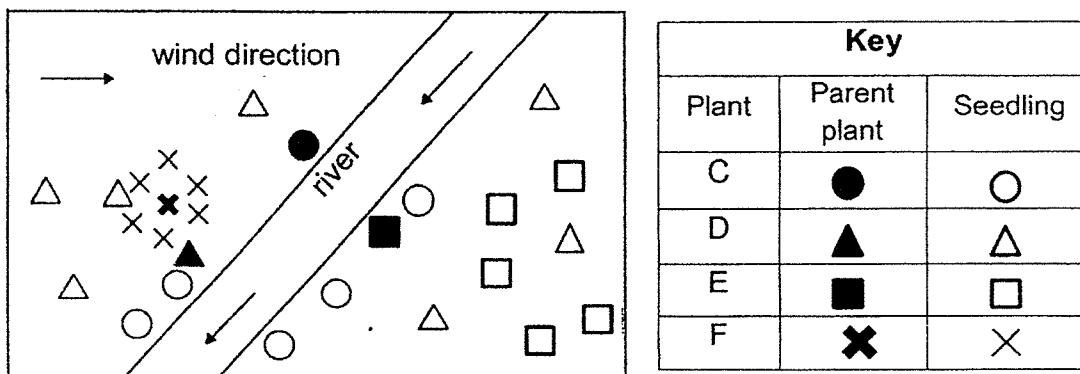

Which of the following characteristics of the fruits correctly match to the seed dispersal method of plants C, D, E and F?

	Plant C	Plant D	Plant E	Plant F
(1)	pod-like structure	hook-like structure	wing-like structure	fibrous husk
(2)	fibrous husk	pod-like structure	hook-like structure	wing-like structure
(3)	pod-like structure	wing-like structure	fibrous husk	hook-like structure
(4)	fibrous husk	hook-like structure	wing-like structure	pod-like structure

(Go on to the next page)

- 13 Joseph cut the stalk of a celery into two equal parts and placed them into two containers with equal amount of water but different coloured dye added.

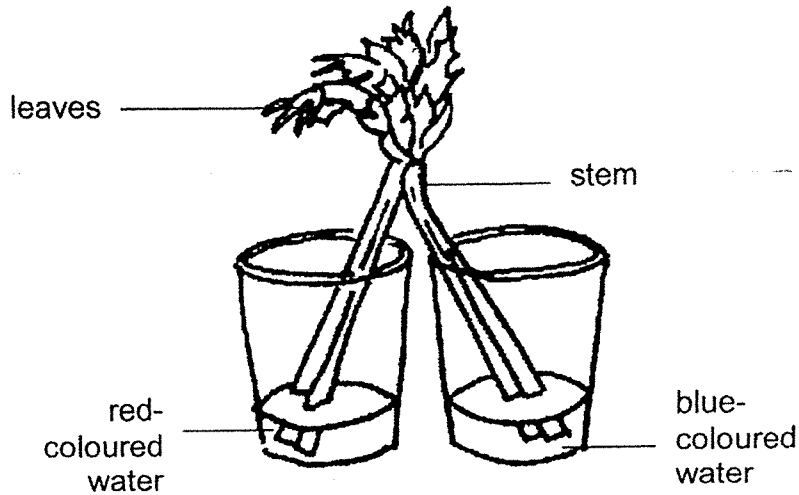

After a while, he observed that some parts of the celery stalk turned red, some turned blue, while the rest remained green.

What could Joseph conclude from his observations?

- A The food made by the plant was red and blue in colour.
 - B The water-carrying tubes transported the different coloured water to the leaves.
 - C There were no water-carrying tubes in the parts that remained green.
- (1) A only
(2) B only
(3) A and C only
(4) A, B and C

(Go on to the next page)

- 14 P, Q, R, S and T are organs in the digestive system. The graph below shows the amount of digested food in each organ after a meal.

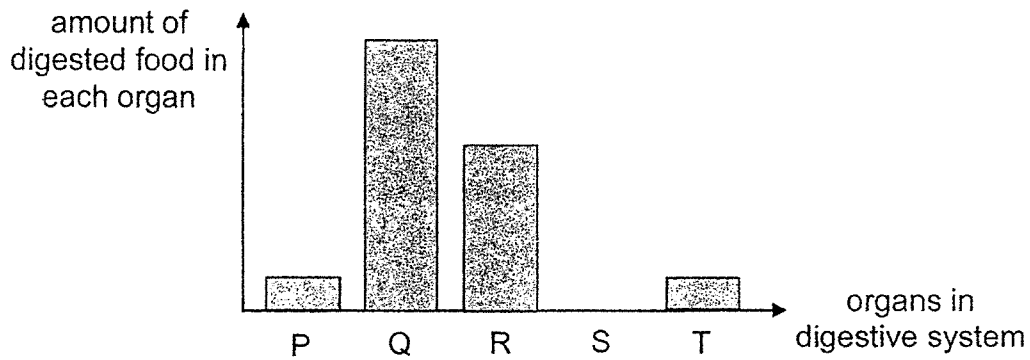

Which of the following is correct?

	Mouth	Gullet	Stomach	Small Intestine	Large Intestine
(1)	Q	T	P	S	R
(2)	Q	R	T	P	S
(3)	P	T	Q	S	R
(4)	P	T	R	Q	S

- 15 Timothy placed a packet of tea into a mug. None of the tea overflowed out, as shown in the picture below.

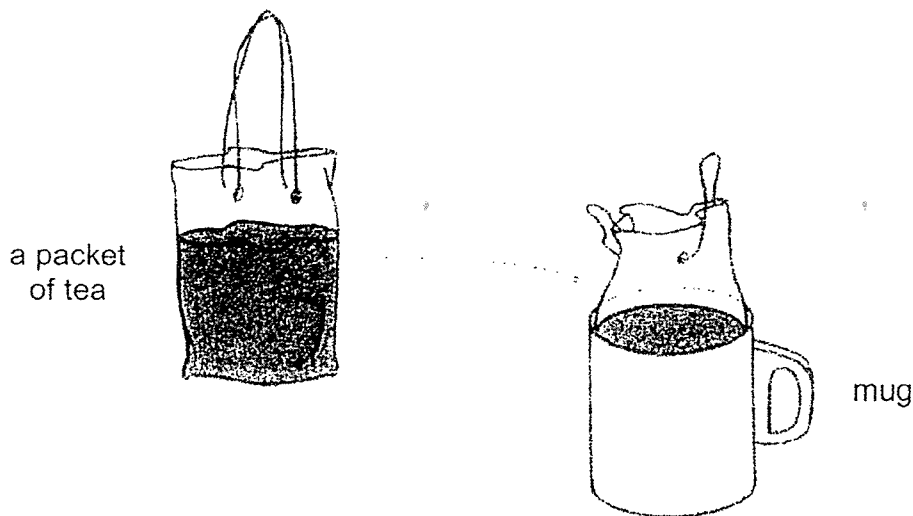

Which of the following about the packet of tea is correct?

- (1) Both the shape and the volume of the tea changed.
- (2) The shape of the tea changed but the volume did not.
- (3) The volume of the tea changed but the shape did not.
- (4) Both the shape and the volume of the tea did not change.

(Go on to the next page)

- 16 A measuring cylinder is used to measure the volume of an object. The diagram below shows a measuring cylinder filled with water.

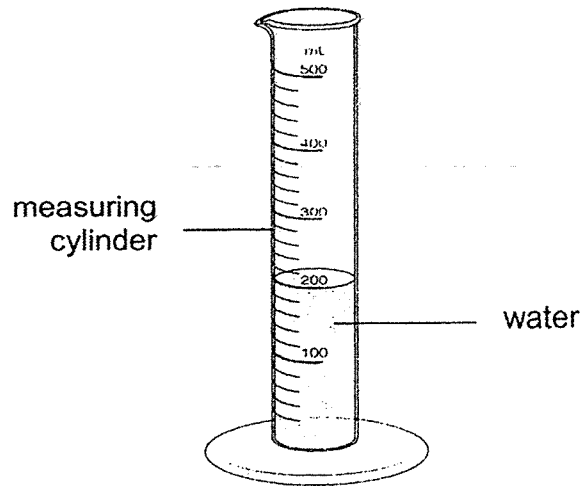

The volume of an object can be found by putting it into the measuring cylinder and observing the change in water level.

The table below shows the properties of four objects, P, Q, R and S.

Object	Does it float in water?	Is it waterproof?	Does it allow light to pass through?
P	No	Yes	Yes
Q	Yes	No	Yes
R	Yes	Yes	No
S	No	No	No

The volume of object ____ can be found using the above method described.

- (1) P
- (2) Q
- (3) R
- (4) S

(Go on to the next page)

- 17 Ruyi tested three types of string J, K and L by hanging weights on each string. She added more weights to each string until it broke. The maximum amount of weight that each string could hold before breaking is shown in the diagrams below.

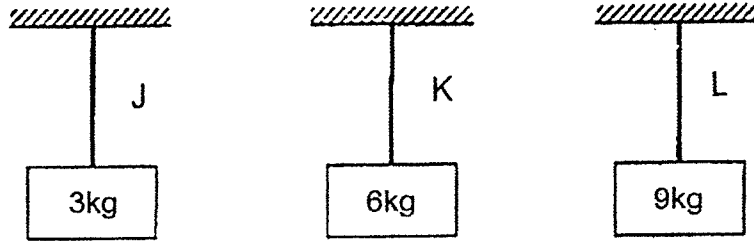

Ruyi decided to hang the weights all in a row, attached at a single point to the top.

Which one of the following arrangements would be possible?

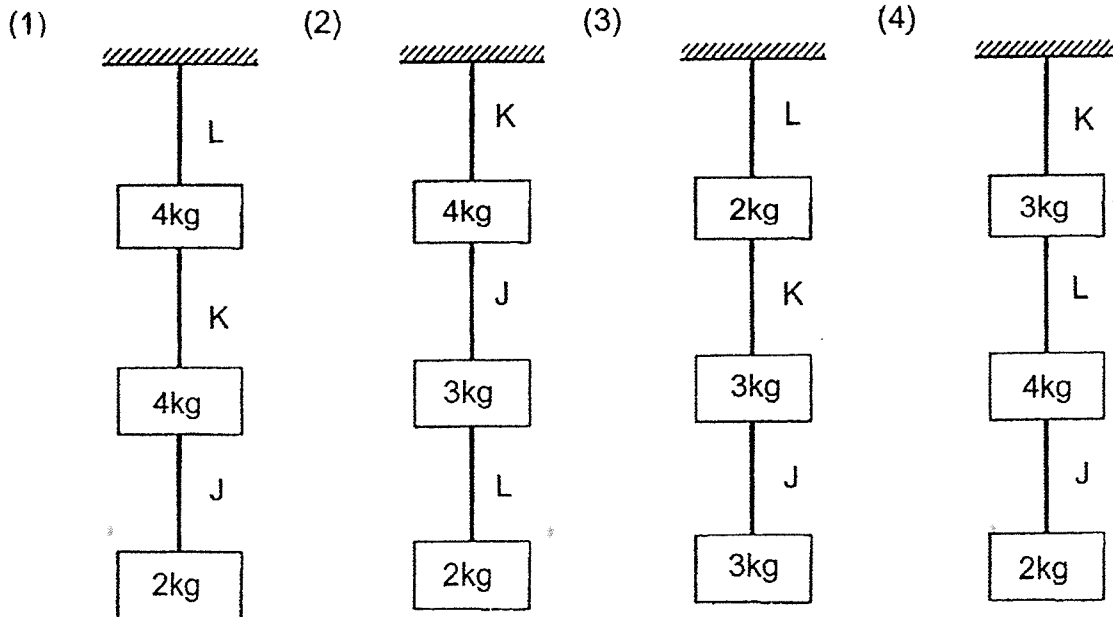

- 18 Which one of the following statements is true?

- (1) Steam is made of water droplets.
- (2) Melting is a process of losing heat.
- (3) Temperature of ice increases during melting.
- (4) Evaporation can take place at any temperature.

(Go on to the next page)

- 19 The table below shows the freezing points and boiling points of three unknown substances, P, Q and R.

Substance	Freezing point (°C)	Boiling point (°C)
P	40	95
Q	32	120
R	28	80

- Which of the substances, P, Q and R is/are liquid at 85 °C?

- (1) P only
- (2) R only
- (3) P and Q only
- (4) Q and R only

- 20 In some buildings, water mist systems are used to cool the surrounding air.

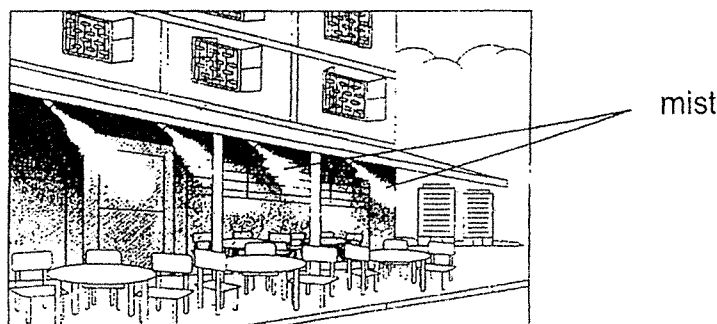

Which of the following explains how mist can cool the surrounding air?

- (1) Water vapour gains heat and condenses into mist.
 - (2) Tiny water droplets lose heat to the surrounding air.
 - (3) Warm surrounding air loses heat to the water droplets.
 - (4) Warm surrounding air gains heat from the water droplets.
- 21 Which of the following is a possible effect on the water cycle when the temperature of the environment decreases?
- (1) Evaporation of water decreases resulting in less rain.
 - (2) Condensation of water vapour increases resulting in less rain.
 - (3) Condensation of water vapour decreases resulting in more clouds.
 - (4) Evaporation of water increases resulting in more water vapour in the air.

(Go on to the next page)

22 Study the electrical circuit below.

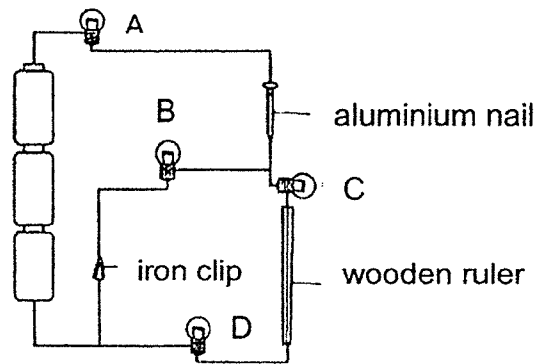

Which bulbs will not light up?

- (1) Bulbs A and B only
- (2) Bulbs C and D only
- (3) Bulbs A, C and D only
- (4) Bulbs A, B, C and D

23 Samuel set up the circuit as shown below.

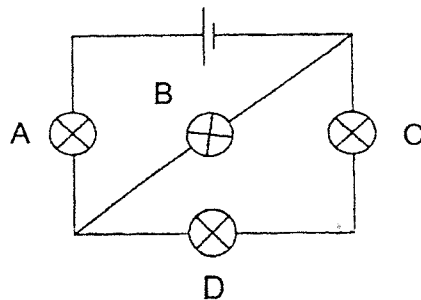

Which one of the bulbs, when fused, would allow the most number of bulbs in the circuit to remain lit?

- (1) Bulb A
- (2) Bulb B
- (3) Bulb C
- (4) Bulb D

(Go on to the next page)

24 Daniel set up an electrical circuit as shown below.

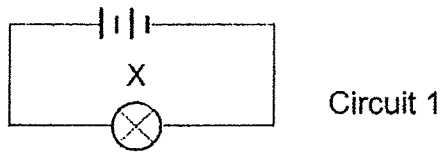

He then added bulb Y to his circuit as shown below.

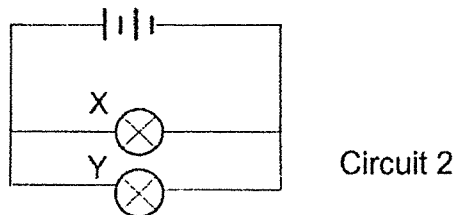

Which of the following graphs correctly shows how the brightness of bulb X changes when bulb Y was added to the electrical circuit?

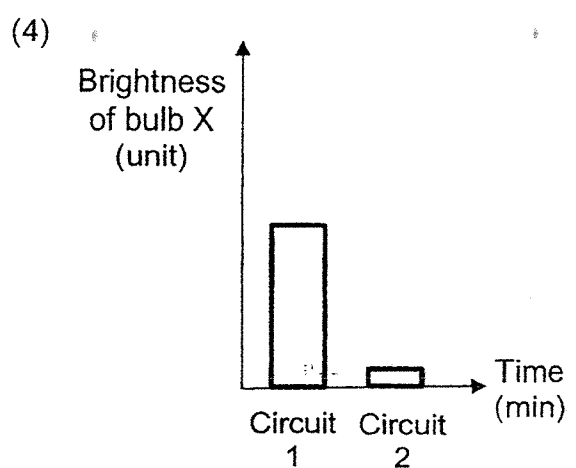
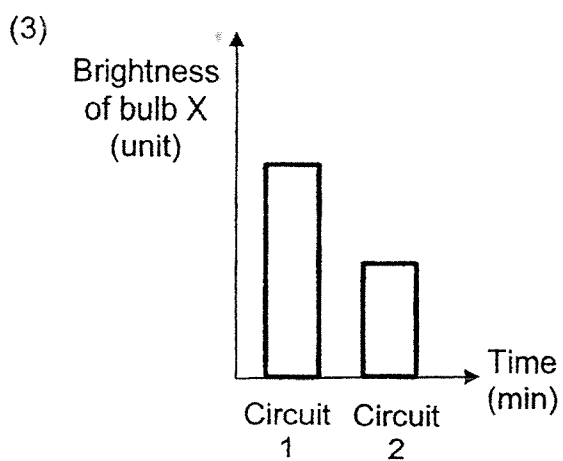
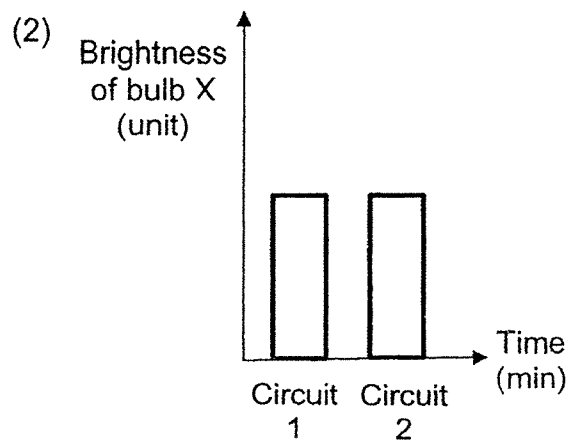
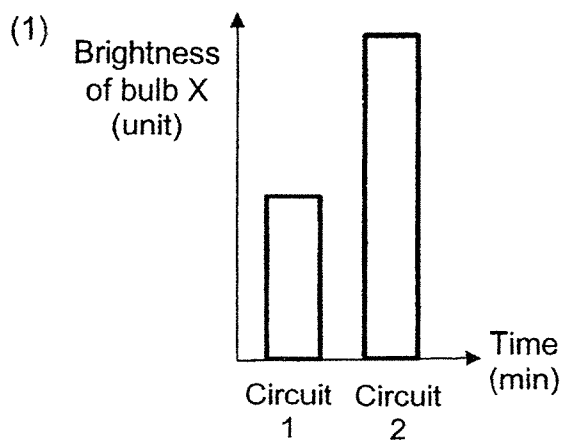

(Go on to the next page)

- 25 Raj sets up an electric circuit as shown below. There are three bulbs, B1 to B3 and five switches in the circuit, S1 to S5. He uses identical switches, bulbs and batteries in his circuit.

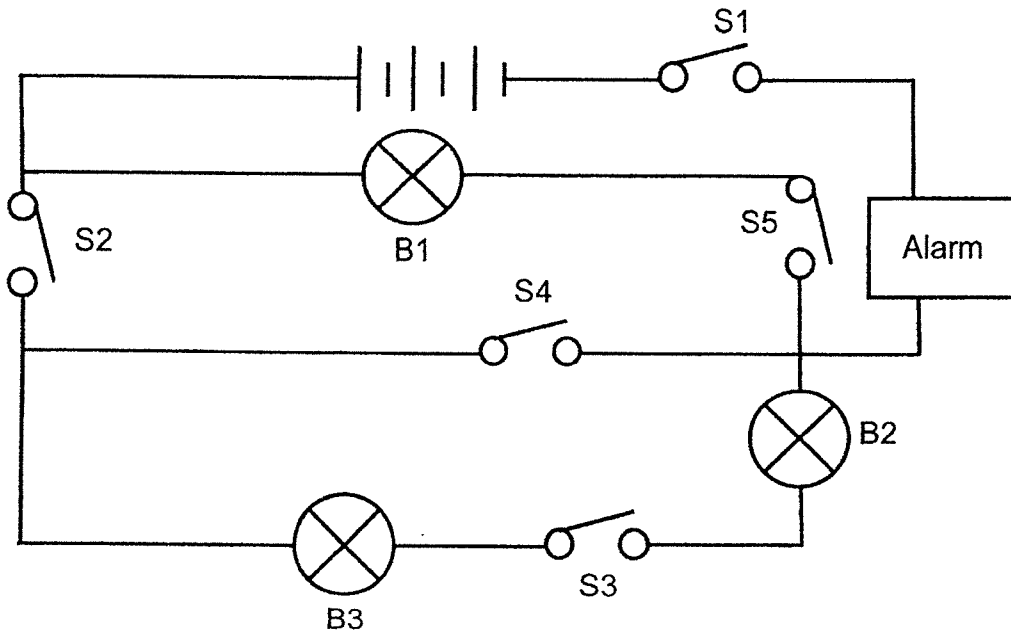

Raj only wants the alarm in his circuit to sound. Which switches should be opened or closed?

	Switch				
	S1	S2	S3	S4	S5
(1)	Close	Close	Open	Open	Open
(2)	Close	Close	Open	Open	Close
(3)	Close	Close	Open	Close	Open
(4)	Open	Open	Close	Open	Close

(Go on to the next page)

- 26 Aishah wanted to investigate how the number of batteries affects the number of paper clips attracted by a rod using the set-up below.

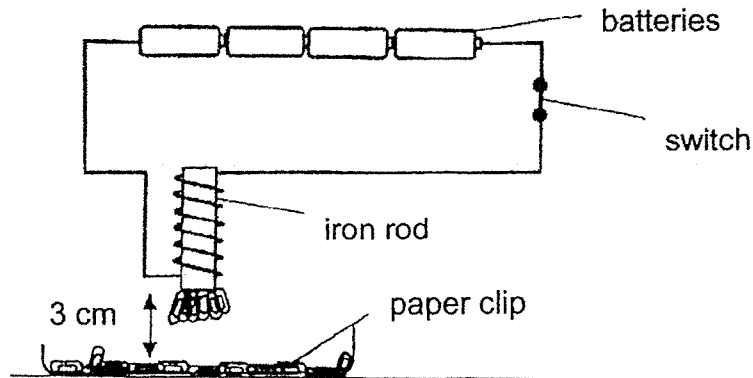

She placed the iron rod 3 cm away from the paper clips and found that it could attract some paper clips. When she added one more battery to the set-up, the number of paper clips attracted did not increase.

What could she do to attract the same number of paper clips when the iron rod was placed 6 cm away from the tray of paper clips?

- (1) Remove two batteries from the set-up.
- (2) Replace the iron rod with a copper rod.
- (3) Increase the number of coils of wire around the iron rod.
- (4) Decrease the number of coils of wire around the iron rod.

(Go on to the next page)

- 27 The graph below shows the changes in the temperature of water over a period of time.

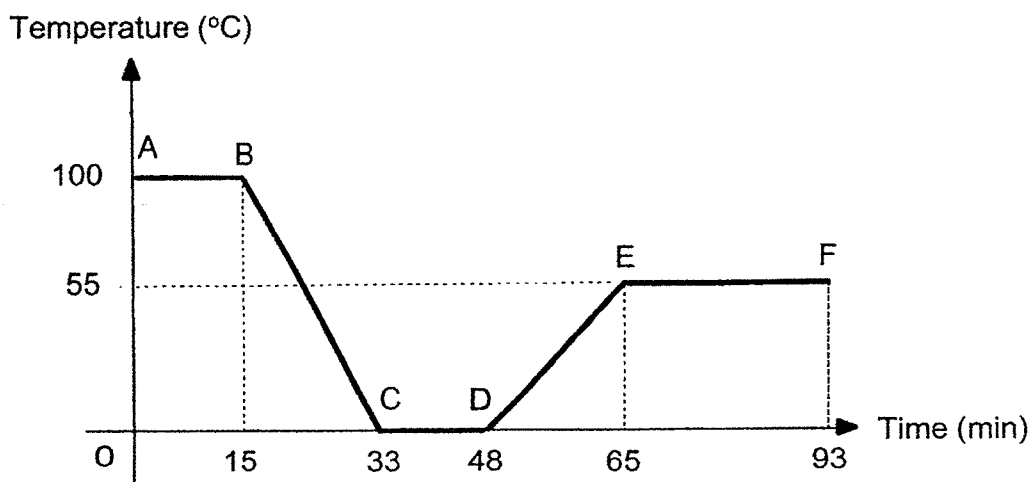

Which one of the following statements is true?

- (1) Water changed into ice only at D.
- (2) From D to E, water was gaining heat.
- (3) Evaporation took place only from E to F.
- (4) Water was freezing for 33 minutes from A to C.

(Go on to the next page)

- 28 Natasha set up the following experiment. She made a rectangular opening on each cardboard screen and lined them as shown in the diagram below.

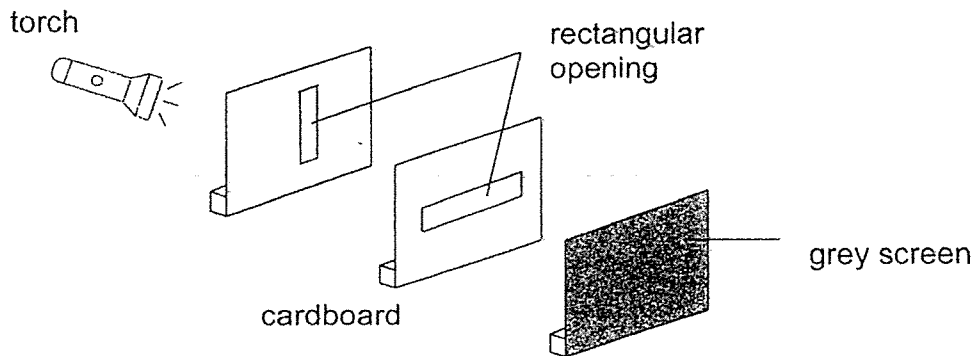

She then switched on the torch and observed the light on the grey screen.

Which of the following would Natasha observe on the grey screen?

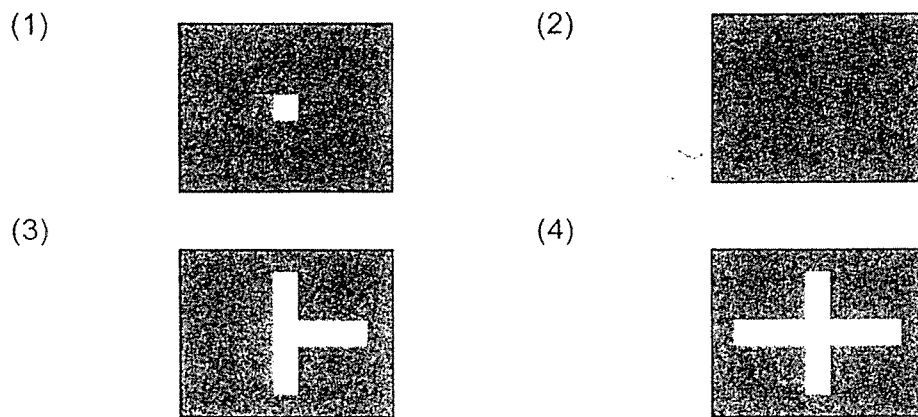

End of Booklet A

METHODIST GIRLS' SCHOOL
Founded in 1887



END-OF-YEAR EXAMINATION 2021
PRIMARY 5
SCIENCE

BOOKLET B

Total Time for Booklets A and B: 1 hour 45 minutes

INSTRUCTIONS TO CANDIDATES

Do not turn over this page until you are told to do so.
Follow all instructions carefully.
Answer all questions.
Write your answers in this booklet.

Name: _____ ()

Class: Primary 5. _____

Date : 26 October 2021

Booklet A	56
Booklet B	44
Total	100
Parent's Signature	

This booklet consists of 17 printed pages including this page.

For questions 29 to 40, write your answers in the spaces provided. The number of marks available is shown in brackets [] at the end of each question or part question. [44 marks]

29 X and Y are produced by the male reproductive organs of two different organisms.

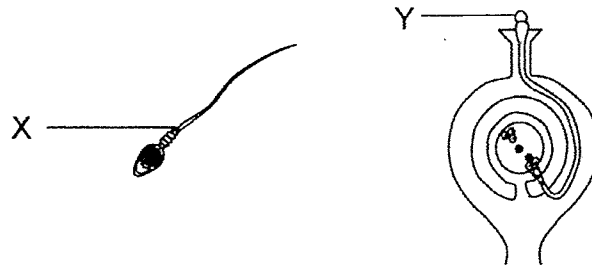

(a) Name the male reproductive cells, X and Y. [1]

(i) X: _____

(ii) Y: _____

(b) Why is X usually produced in large quantities? [1]

The diagram below shows an unfertilised flower with its anthers removed. After some time, the flower developed into a fruit.

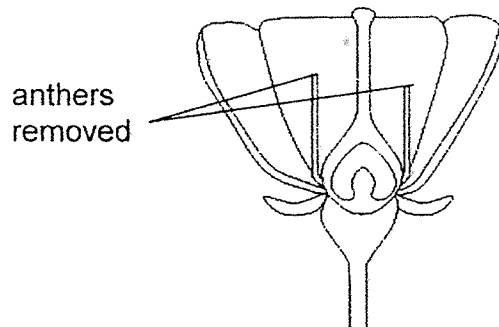

(c) Explain why the flower could still be developed into a fruit.

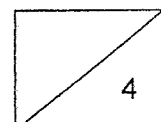

(Go on to the next page)

30 Ali examined two different cells under a microscope and recorded his observations in the table below.

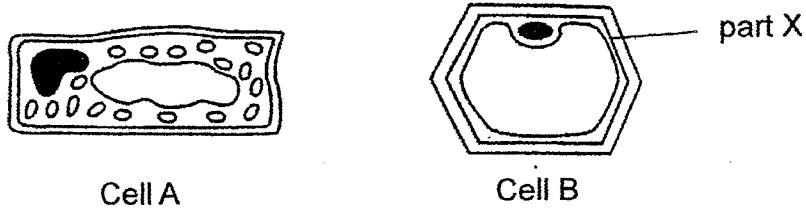

(a) What is part X? Why is part X important to Cell B? [2]

(b) Ali noticed that Cell B does not have chloroplasts like Cell A and concluded that it is not a plant cell. Do you agree with him? Explain your answer. [2]

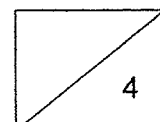

(Go on to the next page)

31 Sonia was given some seeds and she drew the pictures to show the stages of how one of the seeds germinated into a young plant.

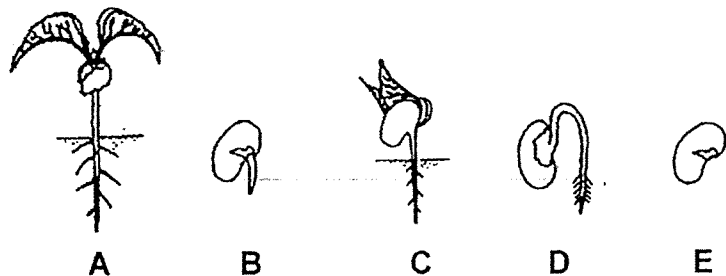

(a) Complete the stages of growth in the life cycle of the plant by filling in the boxes with the letters A, B, C and E. [1]

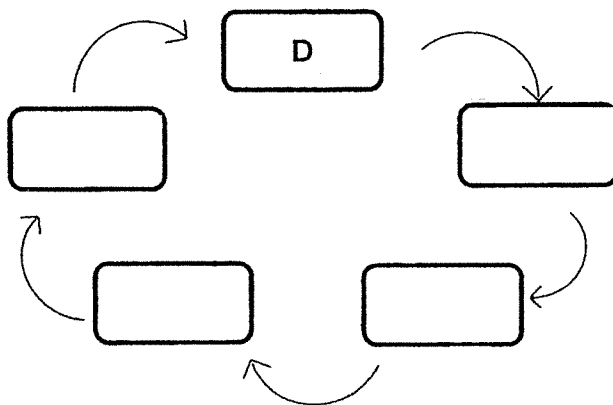

Sonia wanted to find out whether germinating seeds produce heat. She soaked some seeds in water before placing them in a glass flask as shown in set-up A. In set-up B, she used dry seeds instead.

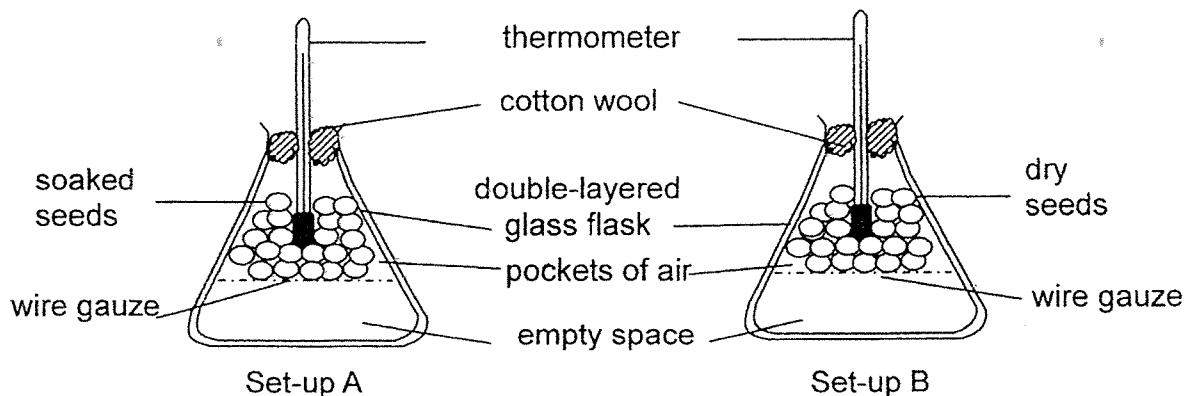

She measured the temperature in the flask and concluded that germinating seeds produced heat.

(Go on to the next page)

- (b) Besides providing air in the flask, give another reason why Sonia did not fill the flask completely with the seeds. [1]

- (c) Explain how using a double-layered glass flask with a layer of air in between helped Sonia to obtain more accurate results. [2]

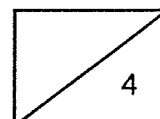

(Go on to the next page)

32 The picture below shows a tree.

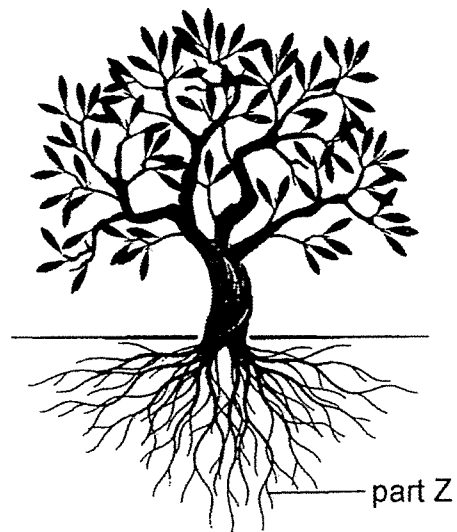

(a) State two main functions of part Z of the tree.

[1]

The diagram below shows the stem of a plant with an outer ring removed.

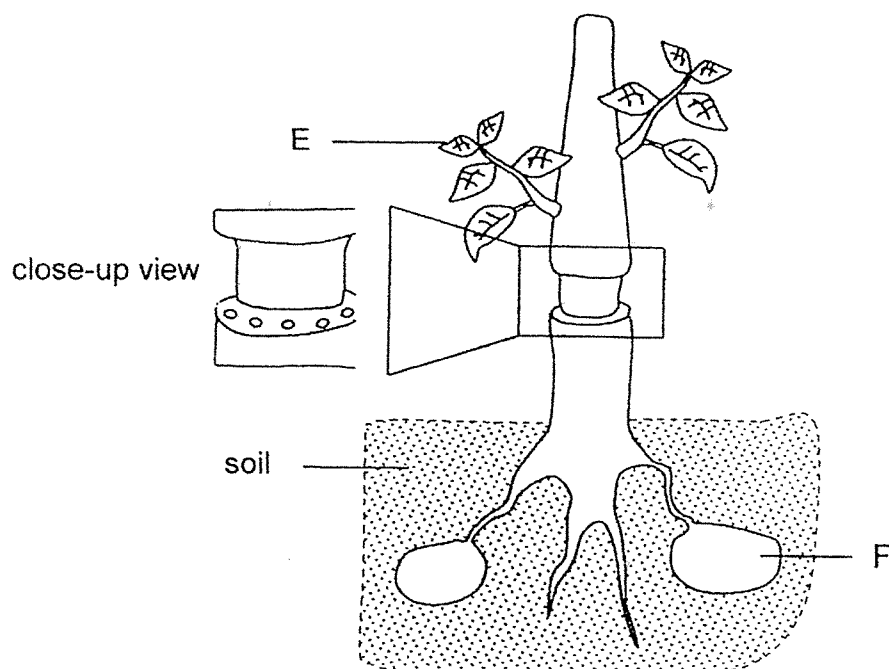

(Go on to the next page)

(b) It was observed that Part E continued to grow bigger after two weeks. Explain why. [2]

(c) Why did Part F remain the same size after two weeks? Explain your answer. [2]

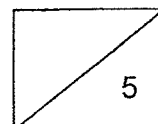

(Go on to the next page)

- 33 The diagram below shows the tiny openings on the underside of a leaf, as well as the gill filaments of a fish.

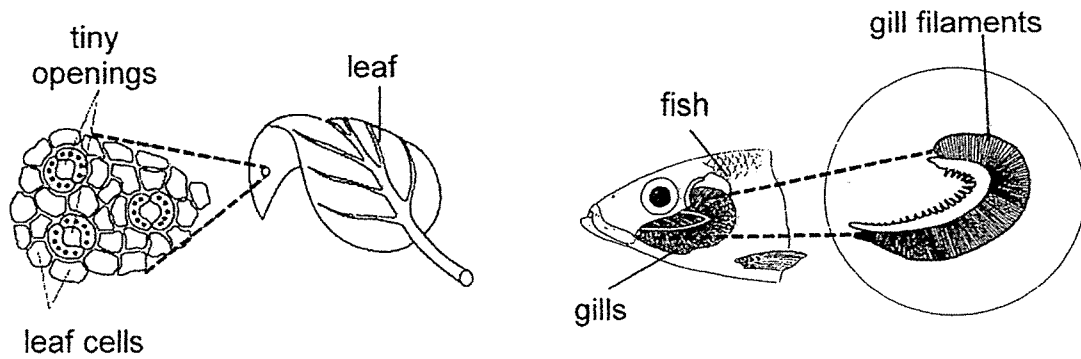

- (a) State one similarity between the functions of the tiny openings on the leaf and the gill filaments of the fish. [1]

- (b) The gills of the fish are made of many gill filaments. What is the advantage of having many gill filaments? [1]

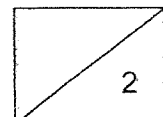

(Go on to the next page)

34 The diagrams below show the lungs of a smoker and a non-smoker. Smoking can cause substances to be trapped in the walls of the air sacs in the lungs, damaging the tissues in the lungs.

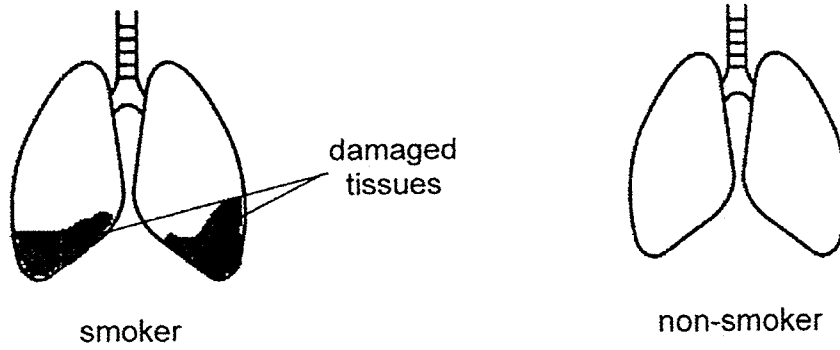

The graph below shows the breathing rates of a smoker and a non-smoker.

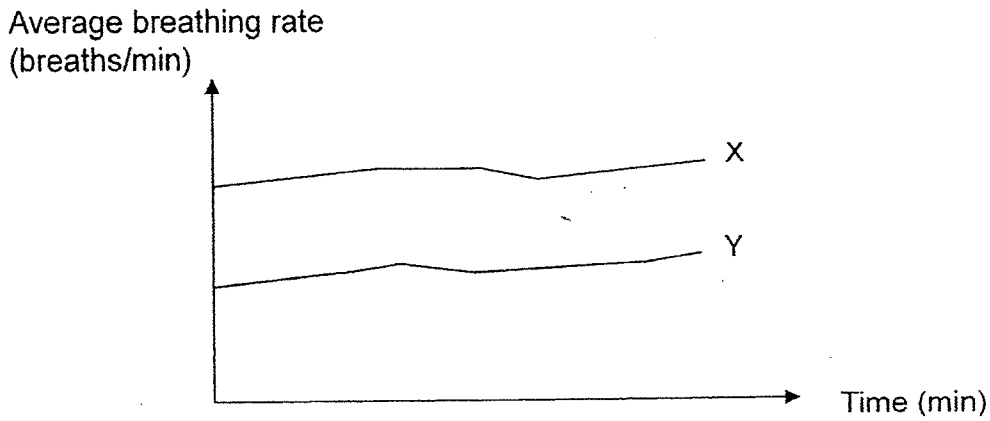

Based on the graph, which line, X or Y, more likely represents the breathing rate of a smoker? Explain your answer. [2]

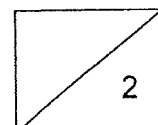

(Go on to the next page)

- 35 Isaac filled his glass with tap water. Then he put some ice cubes into it to make it cooler.

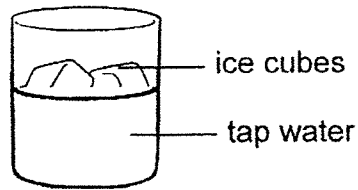

- (a) Explain how adding ice cubes will make the tap water cold. [1]

Isaac found it very difficult to remove the lid of the jar below. He put the jar into a container of hot water for 5 minutes as shown below. He then found that he could remove the lid easily.

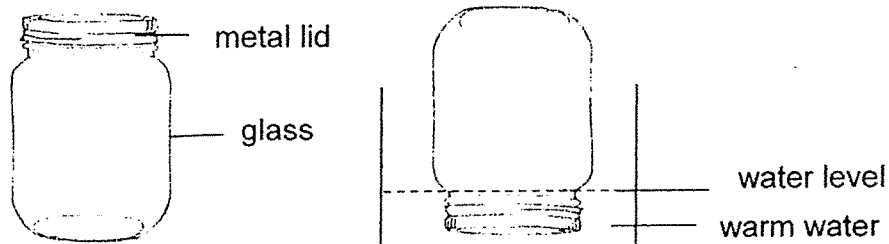

- (b) Explain how putting the metal lid of the jar into warm water made it easier to be removed. [2]

- (c) Isaac tried another method by putting the jar into the freezer.

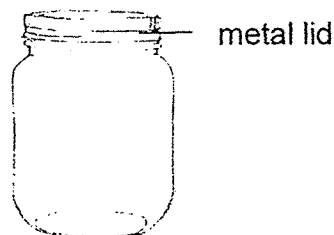

After two hours, he took out the jar from the freezer and tried to remove the metal lid but could not. Explain why. [1]

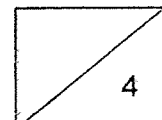

(Go on to the next page)

36 The diagram below shows the human respiratory system.

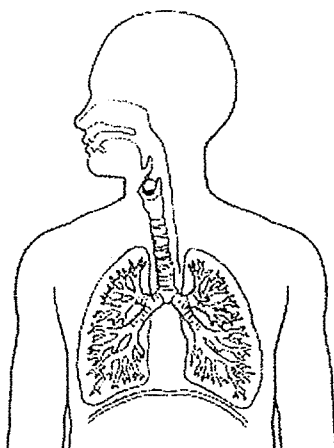

(a) Name the main parts of the respiratory system. [1]

Twelve people were trapped in a lift. Some of the adults started kicking and banging on the door while some young children started crying. The graph below shows the amount of three different gases in the lift at different times.

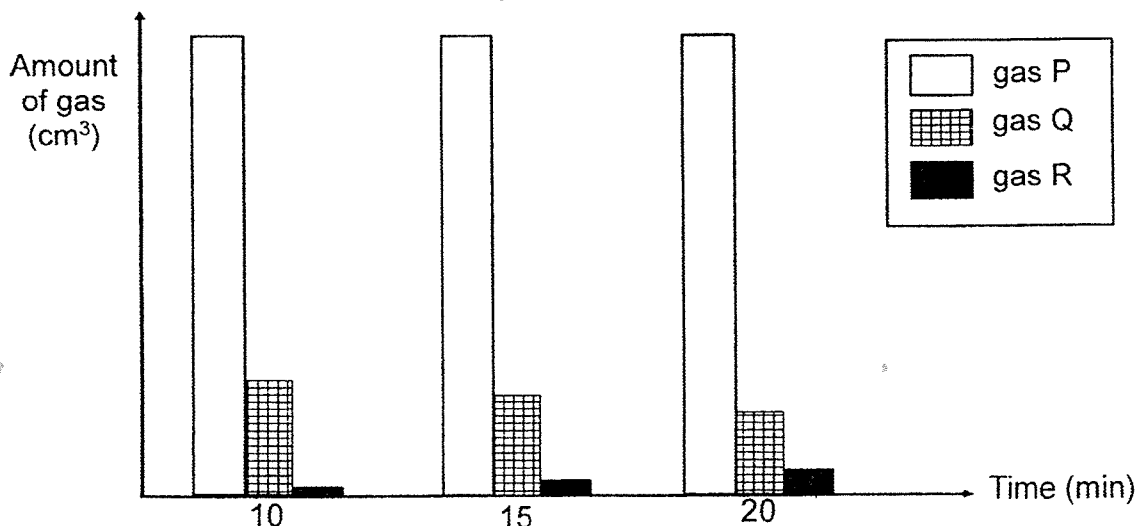

(b) If the adults had not kicked and banged on the lift door and children did not cry, but all of them kept still instead, would the amount of gas Q at the 20th minute be higher, the same, or lower than shown in the graph above? Explain your answer. [2]

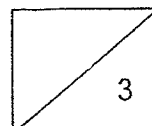

(Go on to the next page)

- 37 Raymond set up a light source and a light sensor to count the number of balls going through a hole as shown.

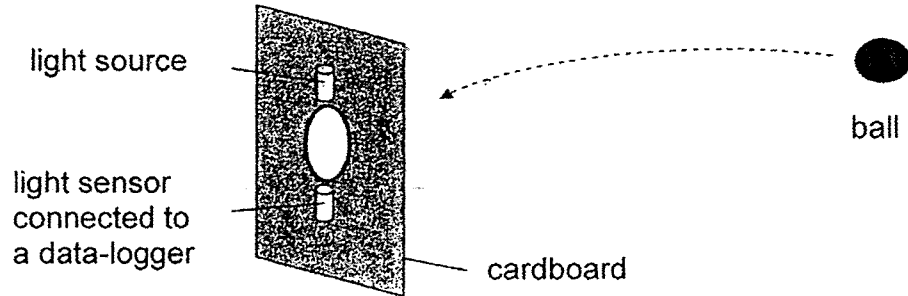

Raymond threw a few identical balls one at a time and recorded the following results.

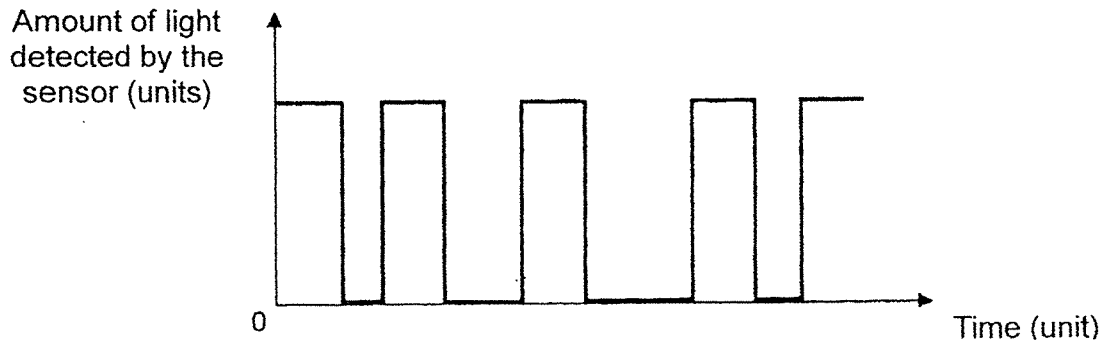

- (a) Based on the graph above, how many balls went through the hole? Explain your answer. [2]

- (b) Explain from the graph above how Raymond knew that the balls went through the hole at different speeds. [1]

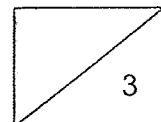

(Go on to the next page)

38 Mr Wong installed two bulbs in two rooms as shown in the diagram below.

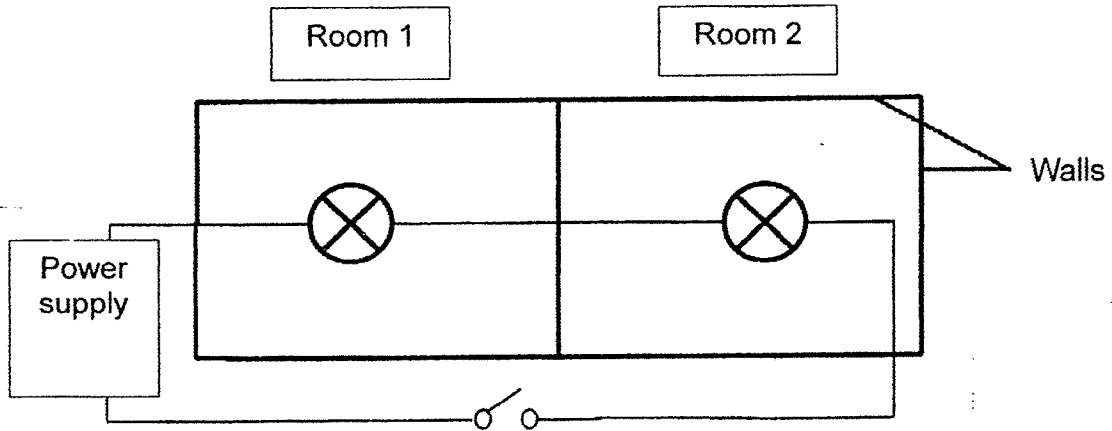

He realised that he could not control the lighting in each room individually.

- (a) Complete the circuit diagram below to show how Mr Wong should connect the electrical components with some wires so that the bulb in each room can be controlled independently. [2]

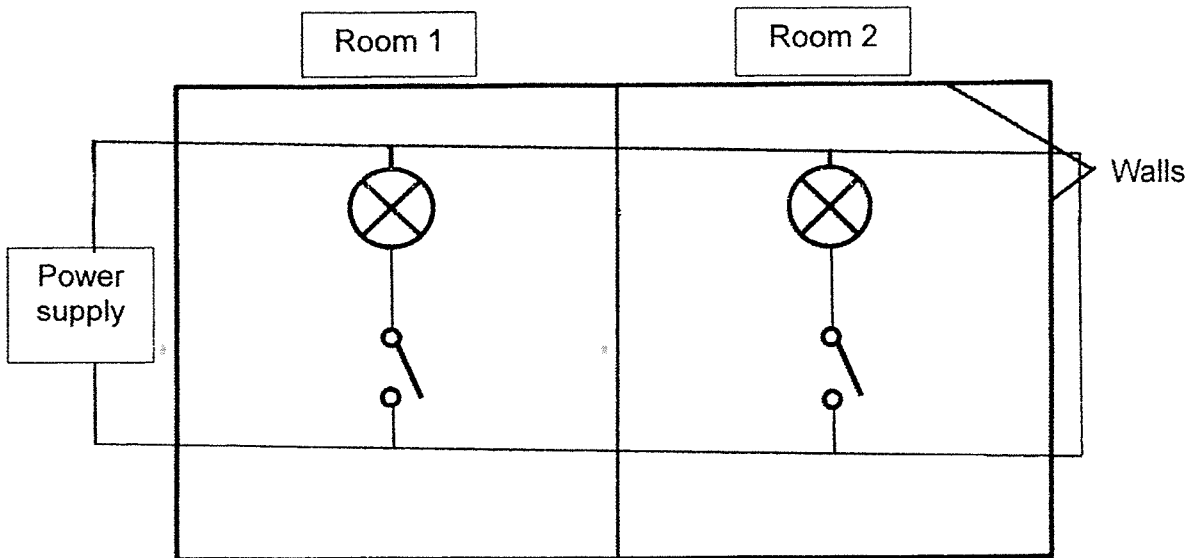

- (b) List another advantage of the circuit you have drawn in (a). [1]

(Go on to the next page)

Mr Wong set up a doorbell as shown below.

The electric circuit and iron cylinder are fixed in place. The iron rod is able to swing about point D. A spring is fixed to the iron rod. The other end of the spring is fixed.

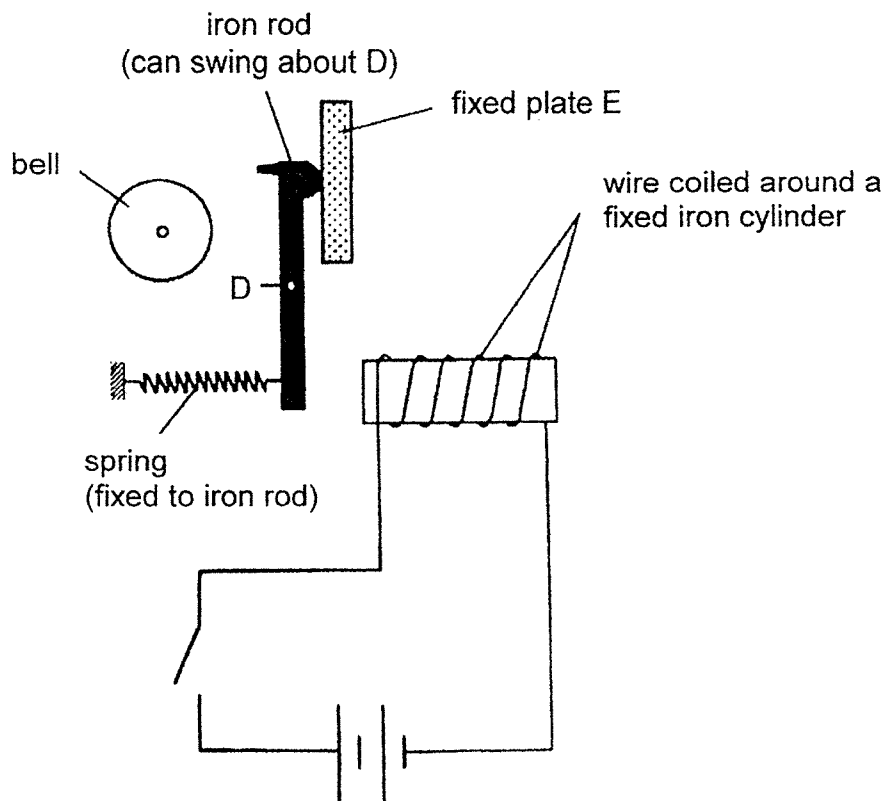

The iron rod hit the bell to produce a “ding” sound when Mr Wong closed the switch. When he opened the switch, the iron rod hit plate E to produce a “dong” sound.

- (c) Explain how the “ding” sound is produced when Mr Wong closed the switch. [2]

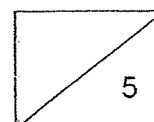

(Go on to the next page)

39 Kamal had a deflated basketball. A fully inflated basketball has a capacity of 7000 cm^3 .



He used an air pump to pump air into the basketball a few times until it was fully inflated. He then recorded the volume of air inside the basketball in the graphs below.

Volume of air in the basketball (cm^3)

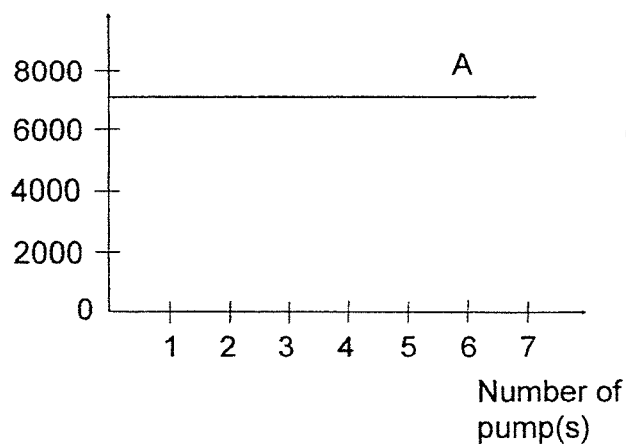

Volume of air in the basketball (cm^3)

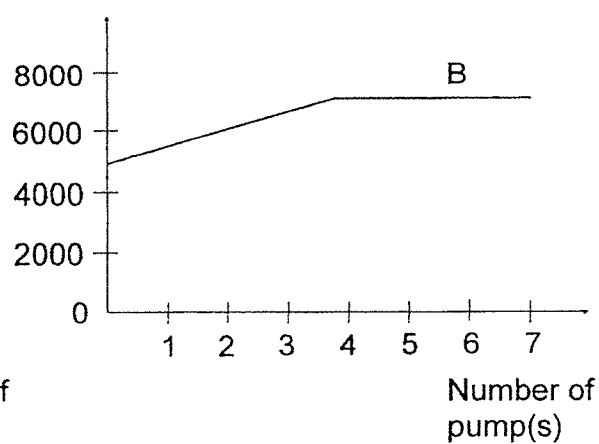

(a) Which line graph, A or B, is drawn correctly to show the volume of air in the deflated basketball to an inflated one? Explain your answer. [2]

(b) When the basketball is fully inflated, Kamal found that he could still pump in more air. Explain why he could do so. [1]

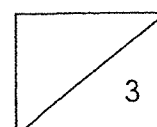

(Go on to the next page)

- 40 Joshua carried out an experiment using the set-ups as shown below. Each beaker contained the same amount of water at different temperatures. He recorded the time taken for the first water droplet to drip from each glass dish.

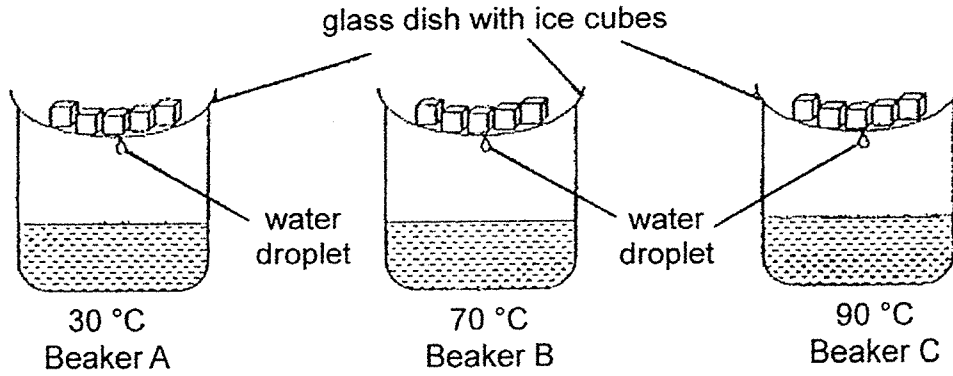

The table below shows the results of his experiment.

Temperature of water (°C)	Time taken for the first water droplet to drip (min)
30	6
70	3
90	2

- (a) Based on the above results, how does the temperature of water affect the rate of evaporation? [1]

- (b) Explain why water droplets in beaker C take the shortest time to form. [2]

(Go on to the next page)

- (c) Did Joshua conduct a fair test? Give a reason for your answer. [1]

- (d) If Joshua used beakers of different sizes for his set-ups, how would his results be affected? [1]

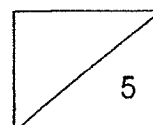

End of Booklet B